

OAW-AP200 Series Wireless Access Point

Installation Guide

The Alcatel OAW-AP204 and OAW-AP205 wireless access points support the IEEE 802.11n and 802.11ac standards for high-performance WLAN. These access points use MIMO (Multiple-in, Multiple-out) technology and other high-throughput mode techniques to deliver high-performance, 802.11n 2.4 GHz and 802.11ac 5 GHz functionality while simultaneously supporting legacy 802.11a/b/g wireless services. The OAW-AP200 Series access points work only in conjunction with an Alcatel Switch.

The Alcatel OAW-AP200 Series access point provides the following capabilities:

- Wireless transceiver
- Protocol-independent networking functionality
- IEEE 802.11a/b/g/n/ac operation as a wireless access point
- IEEE 802.11a/b/g/n/ac operation as a wireless air monitor
- Compatibility with IEEE 802.3af PoE
- Central management configuration and upgrades through a switch



The OAW-AP200 Series requires AOS-W 6.4.1.0 or later.

Package Contents

- OAW-AP204 or OAW-AP205 Access Point
- 9/16" and 15/16" Ceiling Rail Adapters
- Installation Guide (this document)



Inform your supplier if there are any incorrect, missing, or damaged parts. If possible, retain the carton, including the original packing materials. Use these materials to repack and return the unit to the supplier if needed.

OAW-AP200 Series Hardware Overview

Figure 1 OAW-AP200 Series LEDs

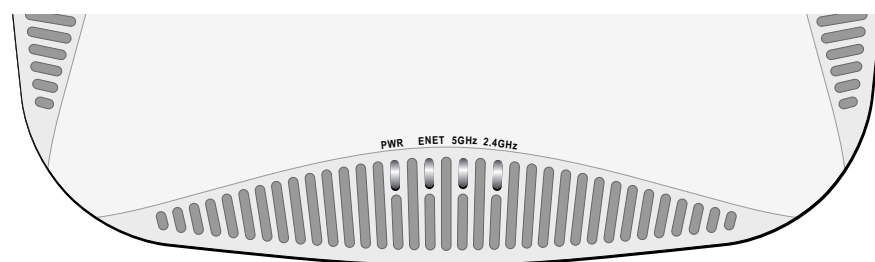

LEDs

The OAW-AP200 Series is equipped with four LEDs that indicate the status of the various components of the AP.

- PWR: Indicates whether or not the OAW-AP200 Series is powered-on and shows basic system status
- ENET: Indicates the status of the OAW-AP200 Series' Ethernet port
- 5 GHz: Indicates the status of the 802.11a/n/ac radio
- 2.4 GHz: Indicates the status of the 802.11b/g/n radio

Table 1 OAW-AP200 Series Series LED Meanings

LED	Color/State	Meaning
PWR	Off	No power to AP
	Red	Error condition
	Green - Flashing	AP booting
	Green - Steady	AP ready
ENET	Off	Ethernet link unavailable
	Yellow - Steady	10/100Mbps Ethernet link established
	Green - Steady	1000Mbps Ethernet link established
	Flashing	Ethernet link activity
5 GHz	Off	5 GHz radio disabled
	Yellow - Steady	5 GHz radio enabled in non-HT WLAN mode
	Green - Steady	5 GHz radio enabled in HT WLAN mode
	Flashing - Green	5 GHz Air or Spectrum Monitor
2.4 GHz	Off	2.4 GHz radio disabled
	Yellow - Steady	2.4 GHz radio enabled in non-HT WLAN mode
	Green - Steady	2.4 GHz radio enabled in HT WLAN mode
	Flashing - Green	2.4 GHz Air or Spectrum Monitor

Figure 2 OAW-AP200 Series Side View (OAW-AP204 shown)

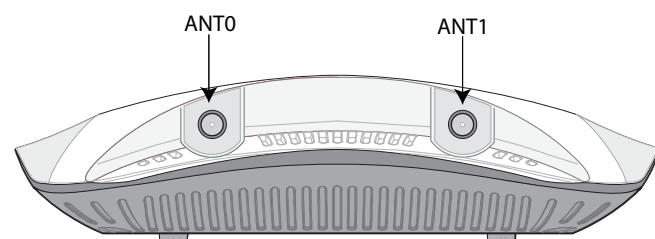

External Antenna Connectors

The OAW-AP204 is equipped with two external antenna connectors. The connectors are labeled ANT0 and ANT1, and correspond to radio chains 0 and 1.

Figure 3 OAW-AP200 Series Rear

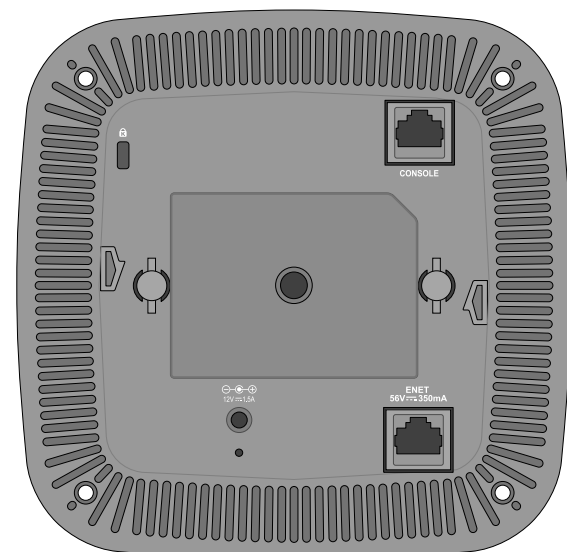

For optimal performance when using articulating direct-mount antennas, professional installers must orient the antennas as pictured in Figure 4, below.

Figure 4 OAW-AP204 Antenna Orientation

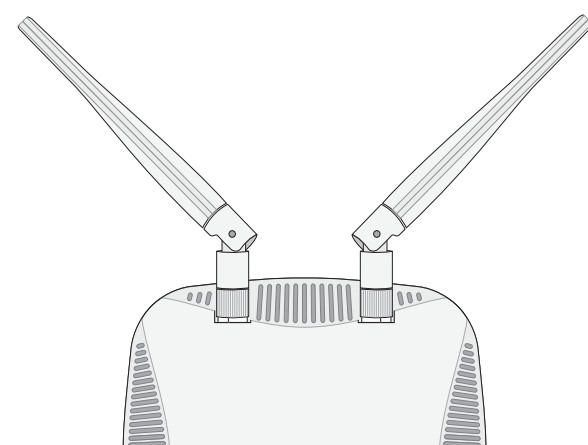

Console Port

The serial console port allows you to connect the AP to a serial terminal or a laptop for direct local management. This port is an RJ-45 female connector with the pinouts described in Figure 5. Connect it directly to a terminal or terminal server using an Ethernet cable.

Figure 5 Serial Port Pin-Out

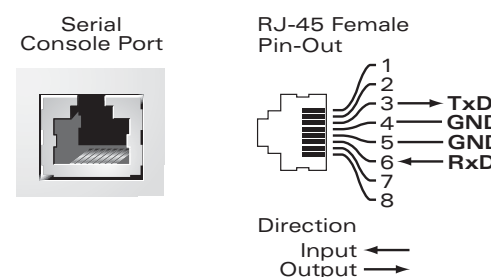

Ethernet Port

OAW-AP200 Series is equipped with one 10/100/1000Base-T (RJ-45) auto-sensing, MDI/MDX wired-network connectivity port. This port supports IEEE 802.3af Power over Ethernet (PoE) compliance, accepting 48 VDC (nominal) as a standard defined Powered Device (PD) from a Power Sourcing Equipment (PSE) such as a PoE midspan injector, or network infrastructure that supports This port has a RJ-45 female connector with the pin-outs shown in Figure 6.

Figure 6 Gigabit Ethernet Port Pin-Out

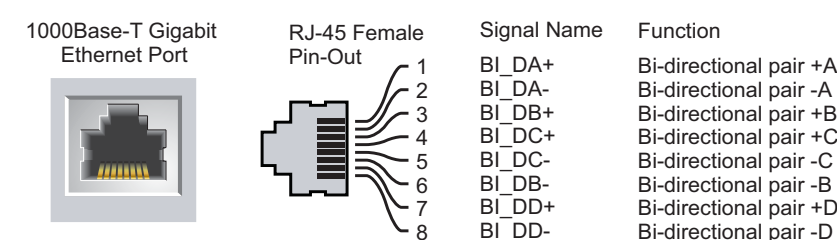

DC Power Socket

If PoE is not available, an optional Alcatel AP AC-DC adapter kit (sold separately) can be used to power the OAW-AP200 Series.

Additionally, a locally-sourced AC-to-DC adapter (or any DC source) can be used to power this device, as long as it complies with all applicable local regulatory requirements and the DC interface meets the following specifications:

- 12 VDC (+/- 5%)/18W
- Center-positive 1.7/4.0 mm circular plug, 9.5 mm length

Reset Button

The reset button can be used to return the AP to factory default settings. To reset the AP:

1. Power off the AP.
2. Press and hold the reset button using a small, narrow object, such as a paperclip.
3. Power-on the AP without releasing the reset button. The power LED will flash within 5 seconds.
4. Release the reset button.

The power LED will flash again within 15 seconds indicating that the reset is completed. The AP will now continue to boot with the factory default settings.

Before You Begin



FCC Statement: Improper termination of access points installed in the United States configured to non-US model controllers will be in violation of the FCC grant of equipment authorization. Any such willful or intentional violation may result in a requirement by the FCC for immediate termination of operation and may be subject to forfeiture (47 CFR 1.80).

EU Statement:

Lower power radio LAN product operating in 2.4 GHz and 5 GHz bands. Please refer to the AOS-W User Guide for details on restrictions.

Produit réseau local radio basse puissance operant dans la bande fréquence 2.4 GHz et 5 GHz. Merci de vous référer au AOS-W User Guide pour les détails des restrictions.



Low Power FunkLAN Produkt, das im 2.4 GHz und im 5 GHz Band arbeitet. Weitere Informationen bezüglich Einschränkungen finden Sie im AOS-W User Guide.

Apparati Radio LAN a bassa Potenza, operanti a 2.4 GHz e 5 GHz. Fare riferimento alla AOS-W User Guide per avere informazioni dettagliate sulle restrizioni.

Pre-Installation Network Requirements

After WLAN planning is complete and the appropriate products and their placement have been determined, the Alcatel switch(s) must be installed and initial setup performed before the Alcatel APs are deployed.

For initial setup of the switch, refer to the AOS-W Quick Start Guide for the software version installed on your switch.

AP Pre-Installation Checklist

Before installing your OAW-AP200 Series AP, ensure that you have the following:

- CAT5e or better UTP cable of required length
- One of the following power sources:
 - IEEE 802.3af-compliant Power over Ethernet (PoE) source. The POE source can be any power source equipment (PSE) switch or midspan PSE device
 - Alcatel AP AC-DC adapter kit (sold separately)
- Alcatel Switch provisioned on the network:
 - Layer 2/3 network connectivity to your access point
 - One of the following network services:
 - Alcatel Discovery Protocol (ADP)
 - DNS server with an "A" record
 - DHCP Server with vendor-specific options

Summary of the Setup Process

Successful setup of an OAW-AP200 Series access point consists of five tasks, which must be performed in this order:

1. Verify pre-installation connectivity.
2. Identify the specific installation location for each AP.
3. Install each AP.
4. Verify post-installation connectivity.
5. Configure each AP.



Alcatel-Lucent, in compliance with governmental requirements, has designed the OAW-AP200 Series access points so that only authorized network administrators can change the settings. For more information about AP configuration, refer to the AOS-W Quick Start Guide and AOS-W User Guide.



Access points are radio transmission devices and as such are subject to governmental regulation. Network administrators responsible for the configuration and operation of access points must comply with local broadcast regulations. Specifically, access points must use channel assignments appropriate to the location in which the access point will be used.

Verifying Pre-Installation Connectivity

Before you install APs in a network environment, make sure that the APs are able to locate and connect to the switch after power on.

Specifically, you must verify the following conditions:

- When connected to the network, each AP is assigned a valid IP address
- APs are able to locate the switch

Refer to the AOS-W Quick Start Guide for instructions on locating and connecting to the switch.

Identifying Specific Installation Locations

You can mount the OAW-AP200 Series access point on a wall or on the ceiling. Use the AP placement map generated by Alcatel's Airwave VisualRF Plan software application to determine the proper installation location(s). Each location should be as close as possible to the center of the intended coverage area and should be free from obstructions or obvious sources of interference. These RF absorbers/reflectors/interference sources will impact RF propagation and should have been accounted for during the planning phase and adjusted for in VisualRF plan.

Identifying Known RF Absorbers/Reflectors/Interference Sources

Identifying known RF absorbers, reflectors, and interference sources while in the field during the installation phase is critical. Make sure that these sources are taken into consideration when you attach an AP to its fixed location. Examples of sources that degrade RF performance include:

- Cement and brick
- Objects that contain water
- Metal
- Microwave ovens
- Wireless phones and headsets

Installing the AP



Service to all Alcatel-Lucent products should be performed by trained service personnel only.

Using the Ceiling Rail Adapter

The OAW-AP200 Series ships with two ceiling rail adapters for 9/16" and 15/16" ceiling rails. Additional wall mount adapters and ceiling rail adapters for other rail styles are available as accessory kits.



Maximum supported weight of the ceiling rail adapter is 3.75 kg.



Make sure the AP fits securely on the ceiling tile rail when hanging the device from the ceiling, because poor installation could cause it to fall onto people or equipment.

1. Pull the necessary cables through a prepared hole in the ceiling tile near where the AP will be placed.
2. Place the adapter against the back of the AP with the adapter at an angle of approximately 30 degrees to the tabs (see Figure 7).
3. Twist the adapter clockwise until it snaps into place in the tabs (see Figure 7).

Figure 7 Attaching the Ceiling Rail Adapter

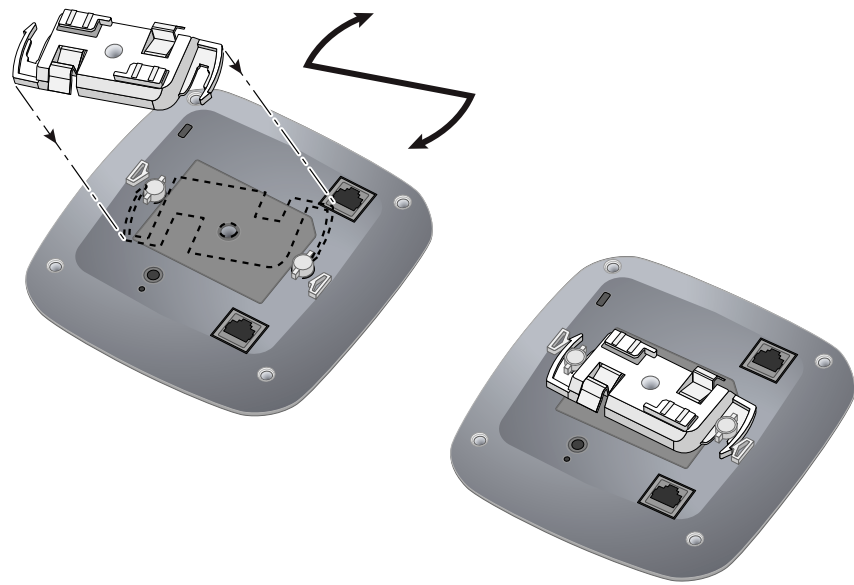

- If necessary, connect the console cable to the console port on the back of the AP.
- Hold the AP next to the ceiling tile rail with the ceiling tile rail mounting slots at approximately a 30-degree angle to the ceiling tile rail (see Figure 8). Make sure that any cable slack is above the ceiling tile.
- Pushing toward the ceiling tile, rotate the AP clockwise until the device clicks into place on the ceiling tile rail.

Figure 8 Mounting the AP

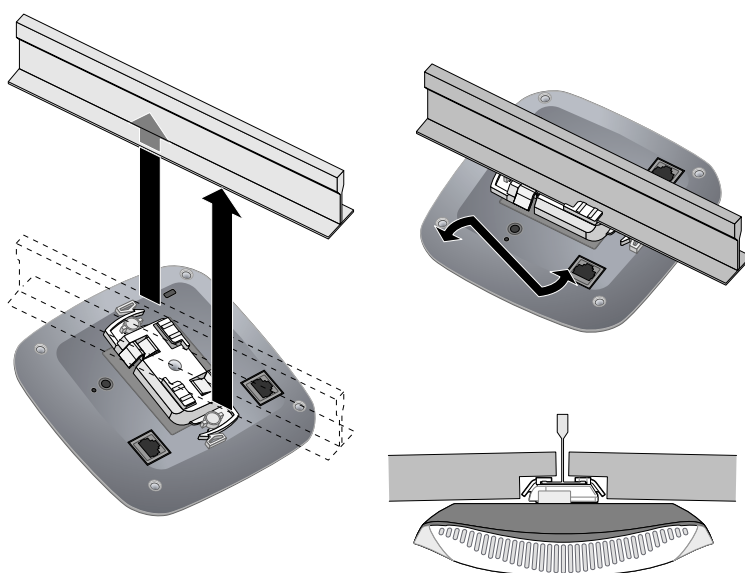

- On the OAW-AP204, install the external antennas according to the manufacturer's instructions, and connect the antennas to the antenna interfaces on the AP.

Connecting Required Cables

Install cables in accordance with all applicable local and national regulations and practices.

Verifying Post-Installation Connectivity

The integrated LEDs on the AP can be used to verify that the AP is receiving power and initializing successfully (see Table 1). Refer to the *AOS-W Quick Start Guide* for further details on verifying post-installation network connectivity.

Configuring the OAW-AP200 Series

AP Provisioning/Reprovisioning

Provisioning parameters are unique to each AP. These local AP parameters are initially configured on the switch which are then pushed out to the AP and stored on the AP itself. Alcatel recommends that provisioning settings be configured via the AOS-W Web UI only. Refer to the *AOS-W User Guide* for complete details.

AP Configuration

Configuration parameters are network or switch specific and are configured and stored on the switch. Network configuration settings are pushed out to the AP(s) but remain stored on the switch.

Configuration settings can be configured via the AOS-W Web UI or AOS-W CLI. Refer to their respective guides for further details: the *AOS-W User Guide*.

Product Specifications

Electrical

- Ethernet:
 - 1x 10/100/1000 auto-sensing Ethernet RJ-45 Interface
 - MDI/MDX
 - IEEE 802.3 (10Base-T), IEEE 802.3u (100Base-T), IEEE 802.3ab (1000Base-T)
 - Power over Ethernet (802.3af compliant), 48V DC (nominal) and 56V DC (maximum)/350mA (see Figure 6 for pin configuration)
- Power:
 - 12 VDC power interface, supports powering through an AC-to-DC power adapter

- POE support on Ethernet port: 802.3af-compliant POE sourcing devices



If a power adapter other than the one provided by Alcatel Networks is used in the US or Canada, it should be cULus (NRTL) Listed, with an output rated 12 VDC, minimum 1.5A, marked "LPS" or "Class 2," and suitable for plugging into a standard power receptacle in the US and Canada.

For additional specifications on this product, please refer to the data sheet. The data sheet can be found at <http://www.alcatel-lucent.com/enterprise>.

Proper Disposal of Alcatel Equipment

For the most current information about Global Environmental Compliance and Alcatel products, see our website at <http://www.alcatel-lucent.com/enterprise>.

China RoHS



Alcatel products also comply with China environmental declaration requirements and are labeled with the "EFUP 10" label shown at the left.

有害物質質聲明
Hazardous Materials Declaration

组件名称 (Parts)	有害物質質元素 (Hazardous Substance)					
	铅 (Pb)	汞 (Hg)	镉 (Cd)	六价铬 (Cr6+)	多溴联苯 (PBB)	多溴二苯醚 (PBDE)
电路板 (PC Board)	x	o	o	o	o	o
机箱附件 (Mechanical Sub-Assemblies)	x	o	o	o	o	o

o, 表示该有害物質質在該组件所有材料中的含量均在 SJ/T11363-2006标准规定的限量要求以下。
Indicate that the concentration of the hazardous substance in all homogeneous materials in the parts is below the relevant threshold of the SJ/T11363-2006 standard.

x, 表示该有害物質質至少在该组件的某一材料中的含量超过 SJ/T11363-2006标准规定的限量要求。
Indicate that the concentration of the hazardous substance of at least one of all homogeneous materials in the parts is above the relevant threshold of the SJ/T11363-2006 standard.

本表格之目的所有产品, 本表格, 表格中的电子产品信息可能包含有害物质。
This table shows where these substances may be found in the supply chain of electronic information products, as of the date of sale of the enclosed product.

此标志为针对涉及产品的环保使用期限标志。某些零部件会有一个不同的环保使用期限(例如: 电话机/固定电话机产品上)。此环保使用期限只适用于产品在产品手册中所规定的条件下工作。
The Environment-Friendly Use Period (EFUP) for all enclosed products and their parts are per the symbol shown here. The Environment-Friendly Use Period is valid only when the product is operated under the conditions defined in the product manual.

European Union RoHS

Alcatel products also comply with the EU Restriction of Hazardous Substances Directive 2011/65/EC (RoHS). EU RoHS restricts the use of specific hazardous materials in the manufacture of electrical and electronic equipment. Specifically, restricted materials under the RoHS Directive are Lead (including Solder used in printed circuit assemblies), Cadmium, Mercury, Hexavalent Chromium, and Bromine. Some Alcatel products are subject to the exemptions listed in RoHS Directive Annex 7 (Lead in solder used in printed circuit assemblies). Products and packaging will be marked with the "RoHS" label shown at the left indicating conformance to this Directive.

India RoHS

This product complies with RoHS requirements as prescribed by E-Waste (Management & Handling) Rules, governed by the Ministry of Environment & Forests, Government of India.

Waste of Electrical and Electronic Equipment



Alcatel products at end of life are subject to separate collection and treatment in the EU Member States, Norway, and Switzerland and therefore are marked with the symbol shown at the left (crossed-out wheelee bin). The treatment applied at end of life of these products in these countries shall comply with the applicable national laws of countries implementing Directive 2002/96/EC on Waste of Electrical and Electronic Equipment (WEEE).

Safety and Regulatory Compliance

Alcatel provides a multi-language document that contains country-specific restrictions and additional safety and regulatory information for all Alcatel access points. This document can be viewed or downloaded from the following location: at <http://www.alcatel-lucent.com/enterprise>.

Regulatory Model Names

The following regulatory model names apply to the OAW-AP200 Series:

- OAW-AP204: APIN0204
- OAW-AP205: APIN0205

정소출력 무선기기 (무선데이터통신시스템용 무선기기)

FCC

This device is electronically labeled. To view the FCC ID:

- Log into the switch WebUI.
- Navigate to **Maintenance > Switch > About**.



RF Radiation Exposure Statement: This equipment complies with FCC RF radiation exposure limits. This equipment should be installed and operated with a minimum distance of 7.9 inches (20 cm) between the radiator and your body for 2.4 GHz and 5 GHz operations. This transmitter must not be co-located or operating in conjunction with any other antenna or transmitter. When operated in the 5.15 to 5.25 GHz frequency range, this device is restricted to indoor use to reduce the potential for harmful interference with co-channel Mobile Satellite Systems.

FCC Class B Part 15

This device complies with Part 15 of the Federal Communications Commission (FCC) Rules. Operation is subject to the following two conditions:

- This device may not cause harmful interference.

- This device must accept any interference received, including interference that may cause undesired operation.



Changes or modifications to this unit not expressly approved by the party responsible for compliance could void the user's authority to operate this equipment.

This equipment has been tested and found to comply with the limits for a Class B digital device, pursuant to Part 15 of the FCC Rules. This equipment generates, uses and can radiate radio frequency energy and, if not installed and used in accordance with the manufacturer's instructions, may cause interference harmful to radio communications.

If this equipment does cause interference, which can be determined by turning the equipment off and on, the user is encouraged to try to correct the interference by one or more of the following measures:

- Reorient or relocate the receiving antenna.
- Increase the separation between the equipment and receiver.
- Connect the equipment to an outlet on a circuit different from that to which the receiver is connected.
- Consult the dealer or an experienced radio or TV technician for help.

Complies with the Class B limits for radio noise emissions as set out in the interference-causing equipment standard entitled "Digital Apparatus," ICES-003 of Industry Canada.

Cet appareil numérique de la classe B respecte toutes les exigences du Règlement sur le matériel brouilleur du Canada.

Users are advised that high power Radars are allocated as primary users of the bands 5250-5350 MHz and 5650-5850 MHz and these Radars could cause interference and/or damage to Licensed Exempt WLAN devices.

해당무선설비는 전파혼선의 가능성이 있으므로 인명안전과 관련된 서비스는 할 수 없습니다.



EU Regulatory Conformance

This product is CE marked according to the provisions of the R & TTE Directive (1999/5/EC) - CE(!). Alcatel-Lucent hereby declares that the APIN0204 / APIN0205 device models are in compliance with the essential requirements and other relevant provisions of Directive 1999/5/EC -CE(!)

The Declaration of Conformity made under Directive 1999/5/EC is available for viewing at <http://www.alcatel-lucent.com/enterprise>.

Canada

(i)Les dispositifs fonctionnant dans la bande 5 150-5 250 MHz sont réservés uniquement pour une utilisation à l'intérieur afin de réduire les risques de brouillage préjudiciable aux systèmes de satellites mobiles utilisant les mêmes canaux;

(ii) le gain maximal d'antenne permis pour les dispositifs utilisant les bandes 5 250-5 350 MHz et 5 470-5 725 MHz doit se conformer à la limite de p.i.r.e.;

(iii) le gain maximal d'antenne permis (pour les dispositifs utilisant la bande 5 725-5 825 MHz) doit se conformer à la limite de p.i.r.e. spécifiée pour l'exploitation point à point et non point à point, selon le cas.

De plus, les utilisateurs devraient aussi être avisés que les utilisateurs de radars de haute puissance sont désignés utilisateurs principaux (c.-à-d., qu'ils ont la priorité) pour les bandes 5 250-5 350 MHz et 5 650-5 850 MHz et que ces radars pourraient causer du brouillage et/ou des dommages aux dispositifs LAN-EL.



Aucune émission n'est permise dans la bande 5 600-5 650 MHz. Jusqu'à nouvel avis, les dispositifs visés par la présente annexe ne doivent pas être en mesure d'émettre dans la bande 5 600-5 650 MHz, afin de protéger les radars météorologiques d'Environnement Canada exploités dans cette bande.



Déclaration concernant l'exposition aux rayonnements de radiofréquences : cet équipement est conforme aux normes d'Industrie Canada relatives aux limites d'exposition humaine aux radiofréquences. Cet équipement doit être installé et utilisé à une distance minimale de 20 cm (7,9 pouces) entre le dispositif de radiocommunication et votre corps dans les gammes de 2,4 GHz et 5 GHz. Cet émetteur-récepteur ne doit pas être placé à proximité immédiate d'une autre antenne ou un d'autre émetteur-récepteur, ou ne doit pas être utilisé conjointement avec ceux-ci.

Medical

- Equipment not suitable for use in the presence of flammable mixtures.
- End product system, including power supply, must be evaluated to IEC 60601-1-1 and IEC 60601-1 by the end user.
- Wipe with a dry cloth, no additional maintenance required.
- No serviceable parts, the unit must be sent back to the manufacturer for repair.
- No modifications are allowed without Alcatel approval.

第十二條

經型式認證合格之低功率射頻電機, 非經許可, 公司、商號或使用者均不得擅自變更頻率、加大功率或變更原設計之特性及功能。

第十四條

低功率射頻電機之使用不得影響飛航安全及干擾合法通信; 經發現有干擾現象時, 應立即停用, 改善至無干擾時方得繼續使用。

前項合法通信, 指依電信法規定作業之無線電通信。

低功率射頻電機須忍受合法通信或工業、科學及醫療用電波輻射性電機設備之干擾。

Korean EMC Class B Warning

이 기기는 가정용(B급) 전자파적합기기로서 주로 가정에서 사용하는 것을 목적으로 하며, 모든 지역에서 사용할 수 있습니다.

OAW-AP200 Series Wireless Access Point Installation Guide



Contacting Alcatel-Lucent

Web Site Support	
Main Site	http://www.alcatel-lucent.com/enterprise
Support Site	https://service.esd.alcatel-lucent.com
Support Email	esd.support@alcatel-lucent.com

Telephone Support	
North America	1-800-995-2696
Latin America	1-877-919-9526
Europe	+800 00200100 (Toll Free) or 1-650-385-2193
Asia Pacific	+65 6240 8484
Worldwide	1-818-878-4507

Copyright

Copyright © 2014 Alcatel-Lucent. All rights reserved. Specifications in this manual are subject to change without notice. Originated in the USA.

Trademarks

AOS-W, Alcatel 4302, Alcatel 4304, Alcatel 4306, Alcatel 4308, Alcatel 4324, Alcatel 4504, Alcatel 4604, Alcatel 4704, Alcatel 4550, Alcatel 4650, Alcatel 4750, Alcatel 6000, OAW-AP41, OAW-AP68, OAW-AP60/61/65, OAW-AP70, OAW-AP80, OAW-AP92/93, OAW-AP104/105, OAW-AP114/115, OAW-AP120/121, OAW-AP124/125, OAW-RAP155, OAW-AP175, OAW-IAP92/93, OAW-AP204/205, OAW-AP214, /215, OAW-AP224/225, OAW-AP274/275, OAW-RAP2, OAW-RAP5, and Omnivista 3600 Air Manager are trademarks of Alcatel-Lucent in the United States and certain other countries. Any other trademarks appearing in this manual are the property of their respective companies.

Legal Notice

The use of Alcatel-Lucent switching platforms and software, by all individuals or corporations, to terminate Cisco or Nortel VPN client devices constitutes complete acceptance of liability by that individual or corporation for this action and indemnifies, in full, Alcatel-Lucent from any and all legal actions that might be taken against it with respect to infringement of copyright on behalf of Cisco Systems or Nortel Networks.®

